



Ministry of Security and Justice

Good governance in a Complex World

Some examples from The
Netherlands

Rian van Gulijk-Boon
Willem Stapel



Subjects

- SD Team at the Ministry of Security & Justice
- Main Trends
- Use of SD and GMB (1): dealing with violence
- Use of SD and GMB (2): staggered payments for traffic fines
- Conclusions



In House SD Team Ministry of S&J



3 full-time fte

+ (when needed) external consultants





Main Trends

- Earlier involvement of stakeholders
- Focus on process, rather than outcome
- GMB in early stage saves time and money later on



SD AND GMB IN PRACTICE

2 CASE STUDIES



1. Dealing with violence in a Dutch city – measures

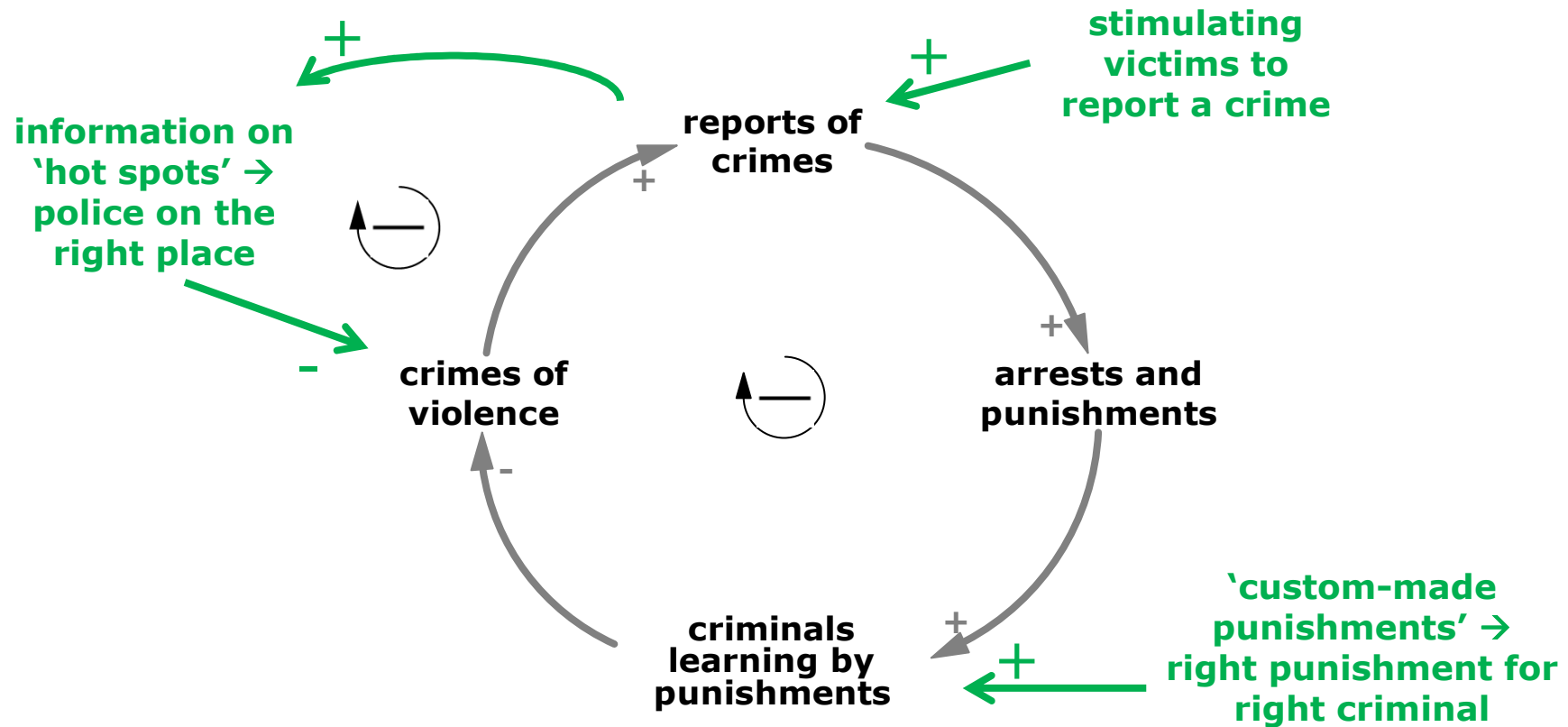

Example of textbook SD problem!



1. Dealing with violence in a Dutch city – research

- Main research questions:
 1. Effects of measures on number of crimes and recidivism?
 2. Effects of measures on workload?

- Methods: SD and GMB

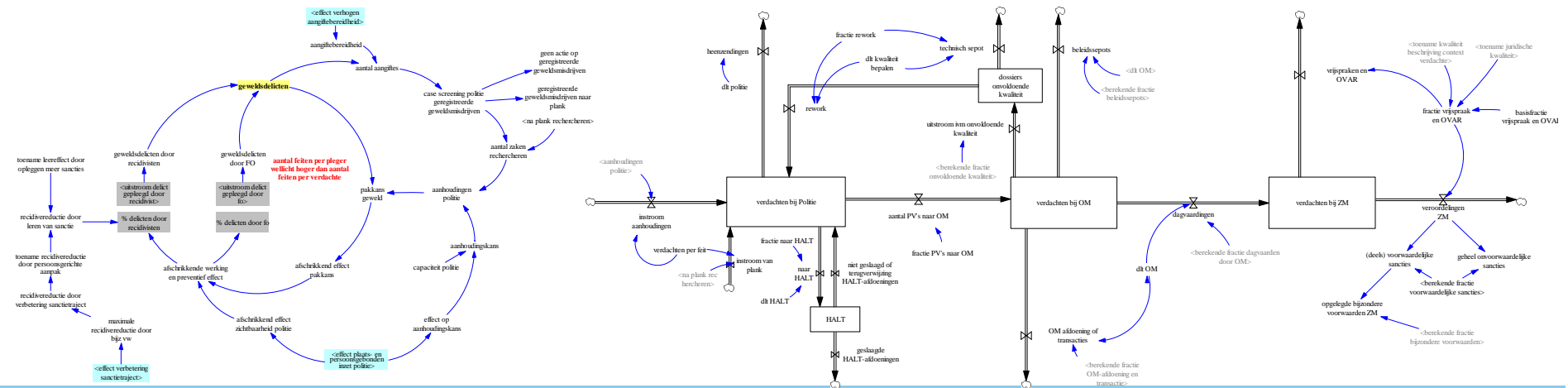



1. Dealing with violence in a Dutch city – conclusions

- Measures lead to reduction in number of crimes of violence...

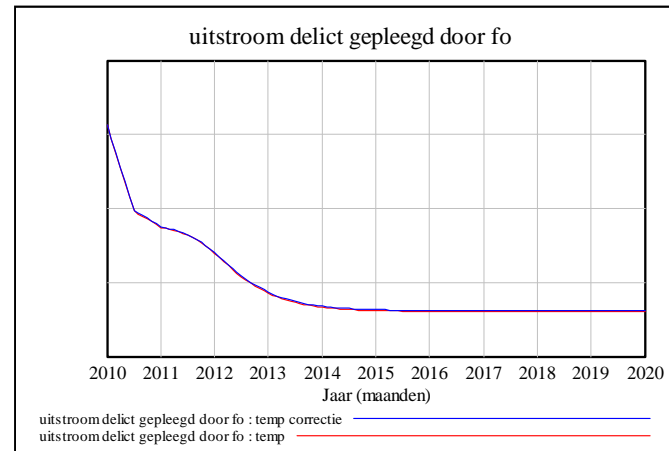

- ...but you can't beat population growth!

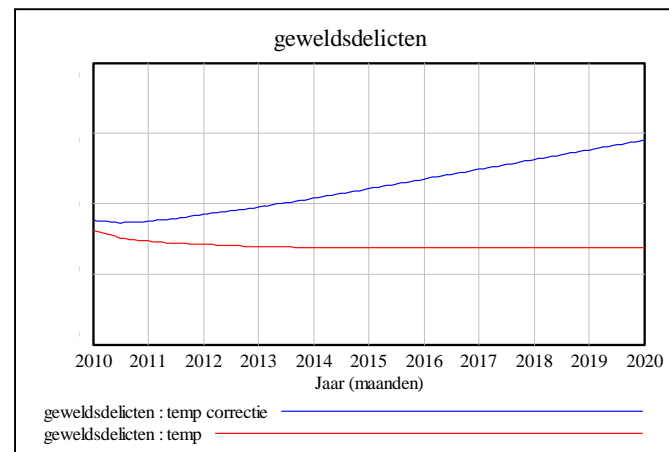



2. Staggered payments for traffic fines – current situation

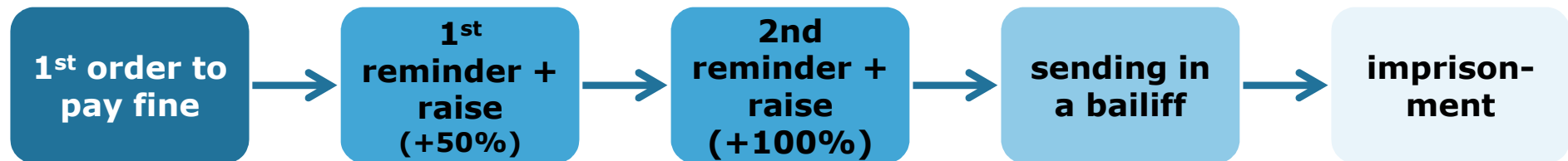

Conditions:

- Fines have to be payed outright
 - If you cannot pay outright, you go to next step
- Problem: currently people who are willing to pay, but cannot pay outright, are imprisoned



2. Staggered payments for traffic fines – research questions

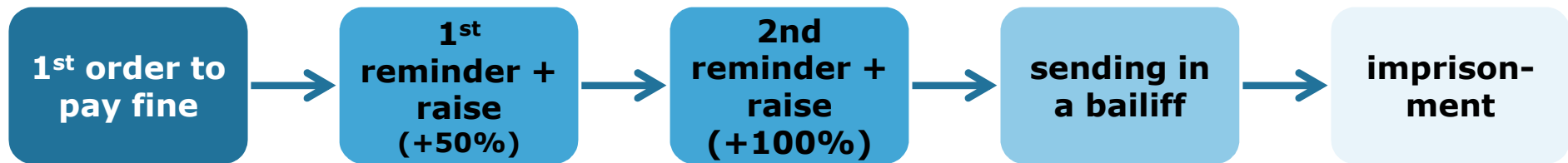

In which step of the collection process should staggered payments be allowed, in respect of:

- higher earnings because more people can pay*
- lower earnings because of less raises*
- extra costs for process of staggered payment*
- lower costs for bailiffs and imprisonment*

Example of (ab)use of Vensim as a fancy calculator...



2. Staggered payments for traffic fines – results

- Lower costs for collection (mainly for imprisonment)
 - Lower earnings because of less raises
 - Slightly negative net effect
- But no more innocent people in prison who want, but cannot pay fines...

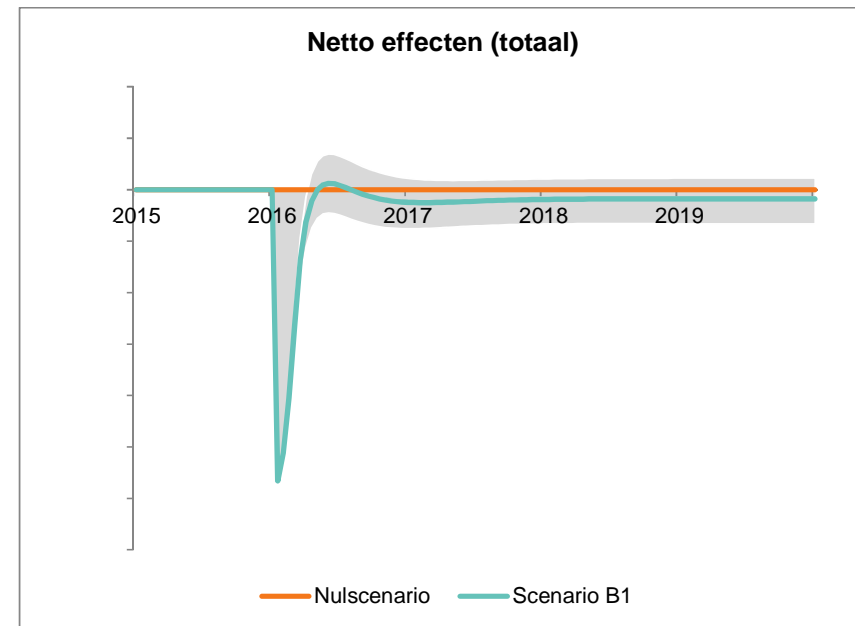

...so let's go for it!



Conclusions

SD has proven to be a very useful tool in Policy Making

..... However, SD is not the only tool in our Tool Box
..... And the process itself is often equally important



Thank you very much !